

[ZL-SS800]

[OPTIONAL BRACKET]

[IN - SWING DOOR APPLICATION]

BRACKET APPLICATION

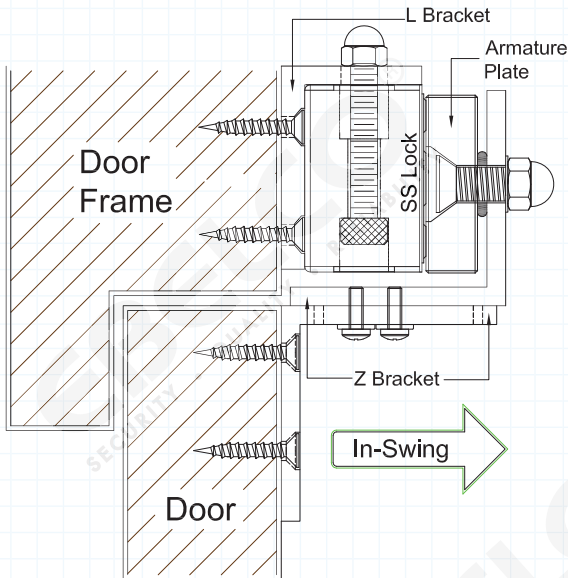

SPECIFICATIONS (UNIT = MM)

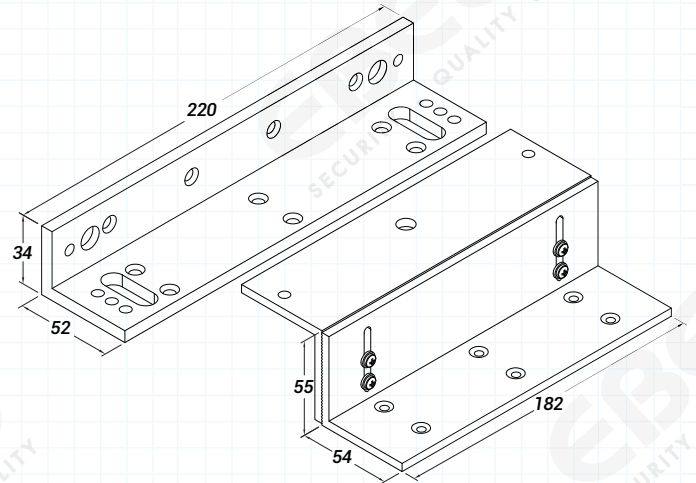

INSTALLATION METHOD

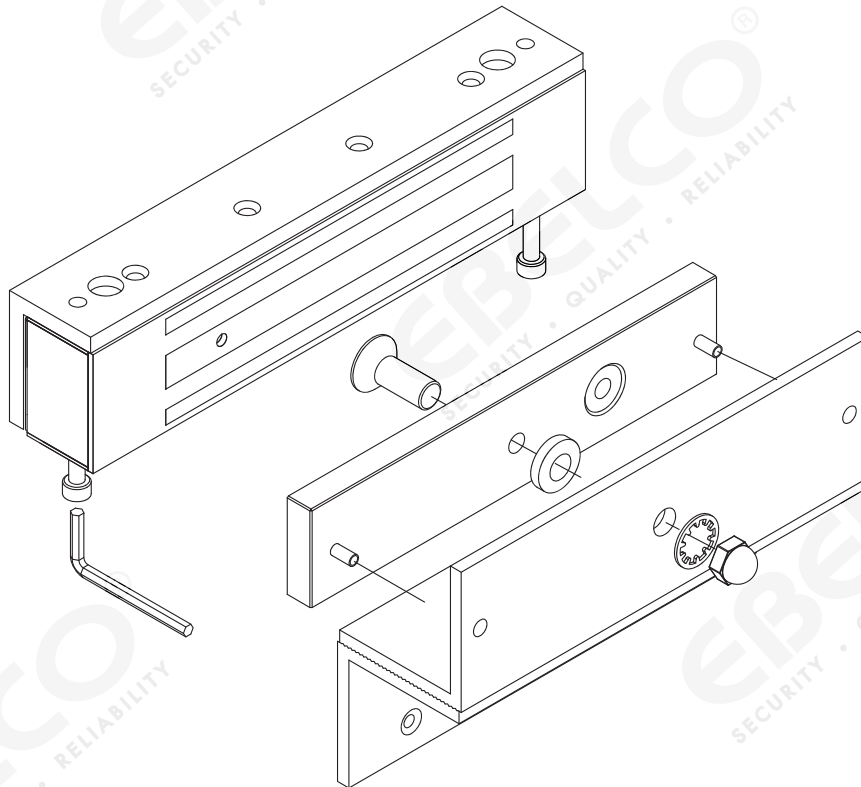

DISCLAIMER : EISB reserve the right to change with any modifications or features or price without forewarning. All the information and specifications stated in this document are current at the time of publication.

SECURITY . QUALITY . RELIABILITY

EBELCO INDUSTRIES SDN. BHD. 474704-V

16, Jalan TTC 26, Taman Teknologi Cheng,
75250, Melaka, Malaysia.

☎ : [+606] 333 8855

📠 : [+606] 333 8822

🌐 : www.ebelco.com

✉ : enquiry@ebelco.com



WWW.EBELCO.COM